

Installation and operating instructions

Photocell LS 41, LS 180

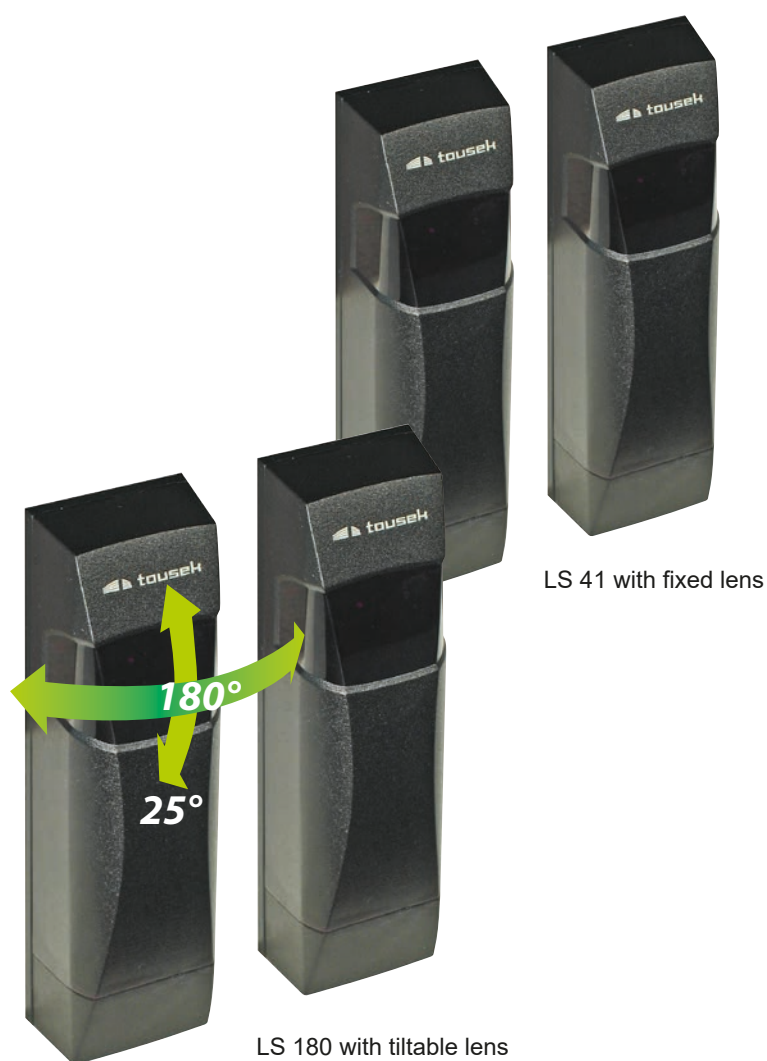



GENERAL WARNING AND SAFETY NOTES

- These installation and operating instructions form an integral part of the product "photocell". They have been specifically written for professional installers trained and skilled in the trade and should be carefully read in their full length before carrying out the installation. They describe the proper installation and operation of the photocell only, not of the overall device "automatic gate". After the installation this manual has to be handed over to the user.
- The EU Machine Directive, laws and rules concerning the prevention of accidents, and laws and standards which are in force in the EU and in the individual countries have to be strictly followed.
- The TOUSEK Ges.m.b.H. cannot be held liable for any claims resulting from disregards of the laws and standards in force during the installation and operation.
- The product may only be used in accordance with its original purpose, for which it has been exclusively designed, and which is described in these installation and operating instructions. The TOUSEK Ges.m.b.H. rejects any liability if the product is used in any way not fully conforming to its original purpose as stated herein.
- The packaging materials (cardboard, plastic, EPS foam parts and filling material etc.) have to be properly disposed of in accordance with the applying recycling- and environmental protection laws. They may be hazardous to children and therefore have to be stored out of children's reach.
- All electrical installations have to be made in full conformity with the applying rules and laws (e.g. using a fault current circuit breaker, proper grounding etc.).
- Only original spare- and replacement parts may be used for repair of the product.
- The TOUSEK Ges.m.b.H. rejects any liability for claims resulting from usage of the product in combination with components or devices which do not fully conform to the applying safety laws and rules.
- The installer has to inform the user about all aspects of the automatic operation of the complete gate facility, as well as about emergency operation. The installer further has to supply to the user all instructions relating to the safe operation of the gate facility. The installation and operating instructions also have to be handed over to the user.
- The user has to be informed that in the event of a malfunction of the product the main switch has to be turned off and the system can only be put into operation again after completion of necessary repairs or adjustments.
- **Installation, connection, adjustments, putting into operation, and servicing may only be carried out by trained professionals in full accordance with these installation- and operating instructions. Faulty installation can result in serious injury and property damage!**
- **The product is not suitable for installation in explosion-hazardous areas. The presence of flammable gases or fumes are a serious danger!**
- **An all-pole disconnecting mains switch with a contact opening gap of min. 3 mm has to be foreseen. The gate facility has to be secured according to the valid safety regulations!**
- **When installing the safety devices (photocells, safety edges, emergency stops, etc.) note the valid standards and directives, the criteria of the code of practice, the assembly environment, the operating logic of the system and the forces of the motorized gate.**
- **The safety devices must protect pinchings, shear points and general hazards of motorized gates.**
- **After installation the proper function of the gate facility and the safety devices has to be checked!**
- **Attach the warning and information signs to identify risk areas.**
- **Before connection works, the mains switch must be turned off!**
- **If the control is power supplied, its inner part is under tension.**
- **In order to avoid electrical strokes, the safety regulations have to be kept.**
- **During connection, adjustment and maintenance works please take care, that the electronic circuit board won't be damaged by moisture (rain).**
- **The manufacturer can not be held liable for damages resulting from improper or unreasonable use of the photocell!**



NOTE concerning cable laying

- **The electric cables have to be laid in insulating sleeves which are suitable for underground usage. The insulating sleeves have to be lead into the inner of the operator housing.**
- **The control lines (buttons, radio, photocells, etc.) have to be laid separately from the 230V lines (supply line, motors, signal lamp).**
- **Only double-insulated cables, which are suitable for underground usage (e.g. E-YY-J) may be used. In case that special regulations require another type of cable, cables according to these regulations have to be used..**

Features

- Modulated infrared-active transmitter-receiver photocell for automatic doors and gates
- Supply voltage 12/24V a.c./d.c.
- Range LS 41: max. 8m, LS 180: max. 20m
- Fixed or tiltable lens
- SYNC-function (active: Jumper (J) removed)
- Measuring points (TP) for optimal alignment
- Easy surface mounting
- 

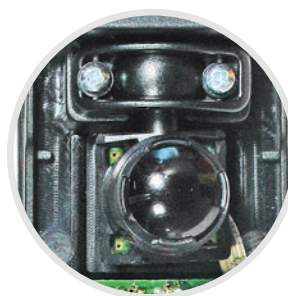
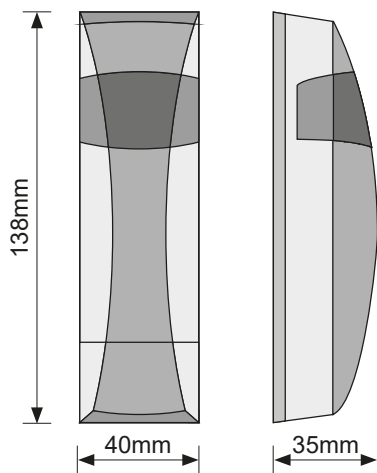

LS 180 with tiltable lens



LS 41 transmitter



LS 41 receiver

Dimensions in mm
Dimensions and technical changes!

General

The surface-mounted photocells LS 41, LS 180 transmitter / receiver photocells, can be used with a supply voltage of 12V or 24V AC/DC. Transmitter and receiver are housed in plastic covers. The lid of this housing is made of special material which acts as a filter to prevent outside influences by sunlight.

LEDs in the transmitter and receiver work as function display. At the receiver board are also 2 measuring points (TP), which are used to optimize the alignment of the photocell by measuring with a voltmeter.

The operation is carried out with modulated infrared light. An interruption in the light beam causes a shifting of the electrical contact in the receiver. The LS 41 has a fixed and the LS 180 a tiltable lens.

As a special feature, the LS 41, LS 180 has a sync function (only with AC power available), which is enabled on the transmitters by removing the jumper (J). Both transmitter and receiver can be mounted without mutual interference on the same side.

Technical data

Photocell	LS 41	LS 180
Power supply	12V bzw. 24V a.c./d.c.	
Power consumption	12/24V a.c.: 95mA, 12/24V d.c.: 63mA	
Signal	infrared, modulated (wave length: 880nm)	
Range	8m	20m
Allowed ambient temperature	-20 up to +70°C	
Potential free relay output	max. 30W, 24V two-way contact (changer)	
Lens	fixed	tiltable: 180° horizontal, 25° vertical
Protection class	IP54	
Dimensions (HxWxD)	138 x 40 x 35mm	
Article number	13510330	13510340
Other	SYNC-function, easy surface mount, plastic housing	



Important

- The LS 41 (LS 180) is a modulated infrared-active transmitter-receiver photocell and can either be operated with **12V or 24V a.c./d.c.**
- In AC-mode by removing the jumper (**J**) the SYNC function is activated (see page 5).
- For the connection of the photocells (LS) connection cables of 0,75mm² have to be used. These have to be connected as mentioned in this manual to the terminals of the LS transmitter and LS receiver. For connection to the control board in question refer to the relevant manual.
- **Lay the connection cable so that excess lengths are avoided.**
- **The terminals of photocells LS 41 and LS 180 are identical**
- The LS 41 differs from the LS 180 by a fixed lens. The lens of the LS 180 is tiltable 180 ° horizontally and 25 ° vertically, thus ensuring precise alignment and flexible mounting options.
Before turning the lens screws (**So**) they must be loosened and then tightened again.

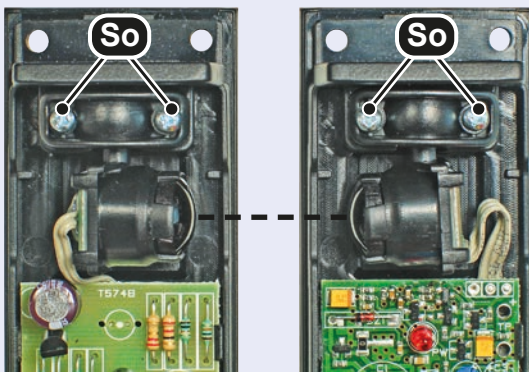

Flexible mounting possibilities:
For example, the LS 180 could be mounted as shown in the figure above.

Transmitter

Receiver

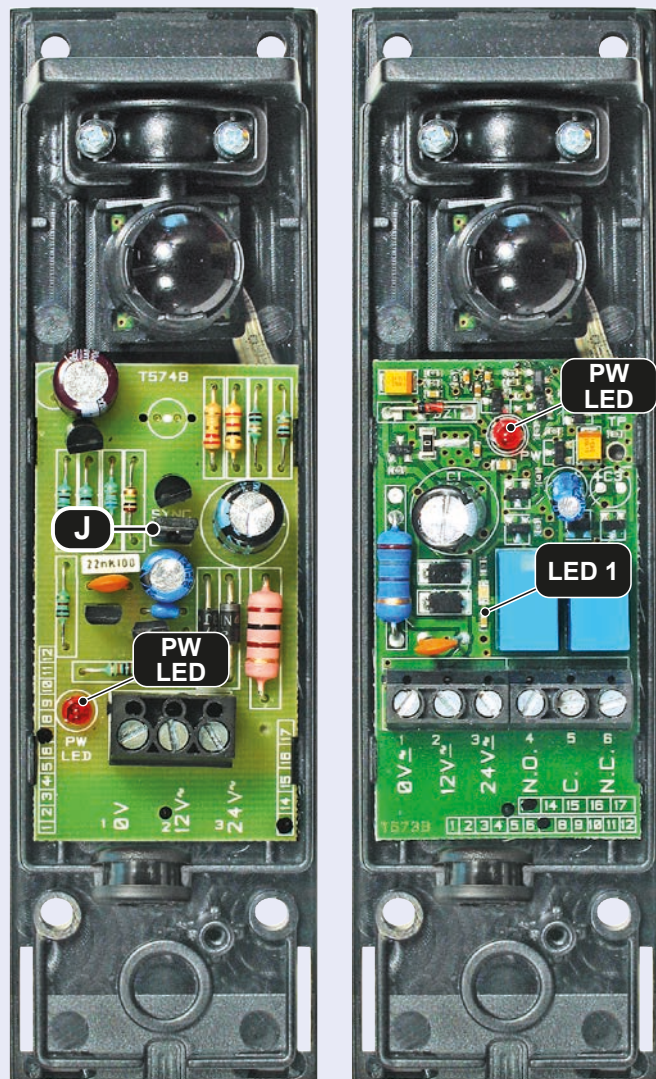

LED-display

Transmitter PW-LED (red)	ON: supply of transmitter OK
Receiver PW-LED (red)	ON: Photocell aligned
Receiver LED 1 (red)	ON: Photocell not aligned



Note: LS-contact (receiver) between terminal 5 and 6 opens during beam interruption.

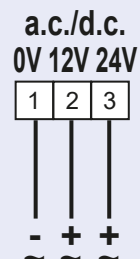

currentless (triggered)
contact appearance

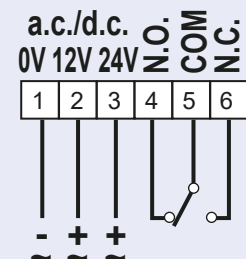



Photocell connection / SYNC-function

- To prevent mutual interference when using two pairs of photocells, the two photoelectric sensor transmitter and receiver must not be installed **on the same side**.

Exception: Photocells with **SYNC function** (only possible when AC power supply LS) allow the assembly of both photoelectric sensor transmitter and receiver on the same side.

The LS 41 (LS 180) supports the SYNC-function.

- Enabling the SYNC function:** when the SYNC function is desired with LS 41 (LS 180), the jumper J has to be removed in both photoelectric transmitters!

Standard:

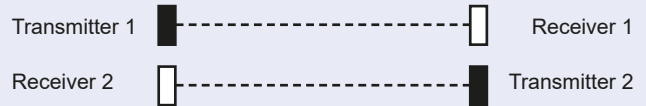

with SYNC-function:

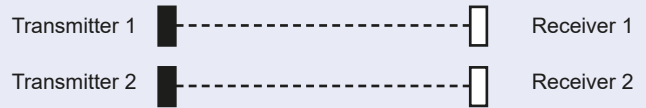

SYNC-function

Jumper J placed	no SYNC-mode
Jumper J removed	SYNC-mode activated

The SYNC-function is only possible in AC mode!

Power supply with alternating current (a.c.)

- If the photocells are supplied with alternating current (ac), then the SYNC function is turned on by removing the transmitter jumper (J).



Important

- Make sure the AC voltage connection is made as shown in the following drawing so that the necessary phase shift of 180 ° takes effect for the SYNC function.

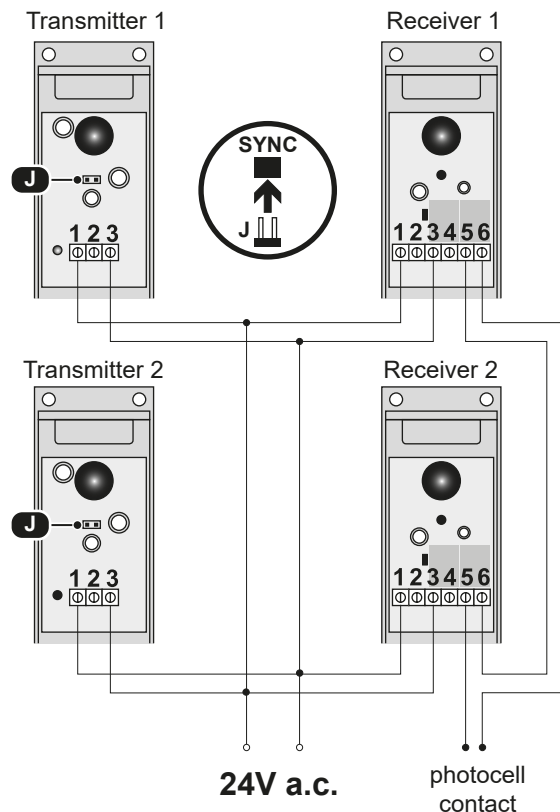

Power supply with direct current (d.c.)

- If only direct current supply(DC) is available, the sync function is not possible. The transmitter jumper (J) remains set.



Important

- The two photocell transmitters and receivers must not be installed on the same side in order to avoid mutual interference.

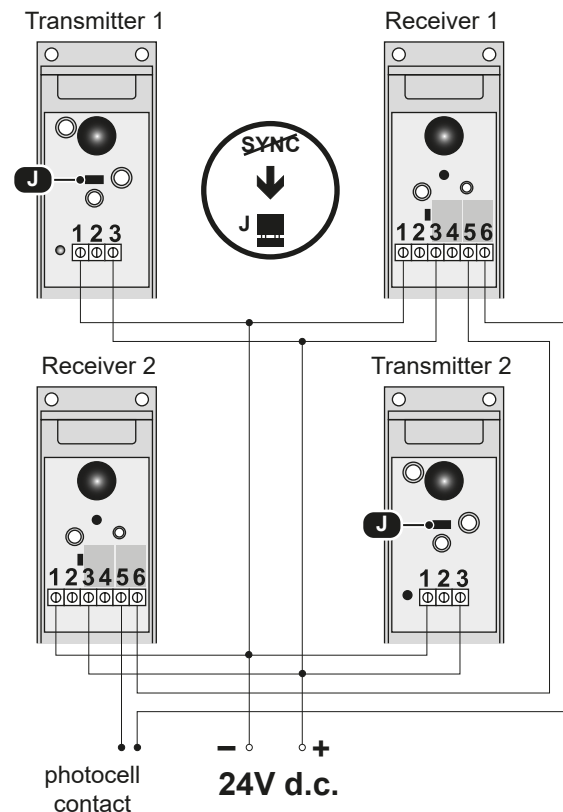

Important: Photocell connection

The above diagrams are only general connection examples!

in tousek control units photocell transmitters and receivers normally are connected to different voltage supply terminals. Therefore keep in mind the instructions and connection diagrams of the corresponding control board- or automation device manual !



Mounting positions

- Set mounting positions for the transmitter and receiver. It is important to ensure that the mounting positions for the transmitter and receiver, are defined opposite with the same axis alignment and in the same height.
- It should be noted that the height H is adjusted to the site conditions and requirements.
- The applicable guidelines for power-operated doors must be observed!

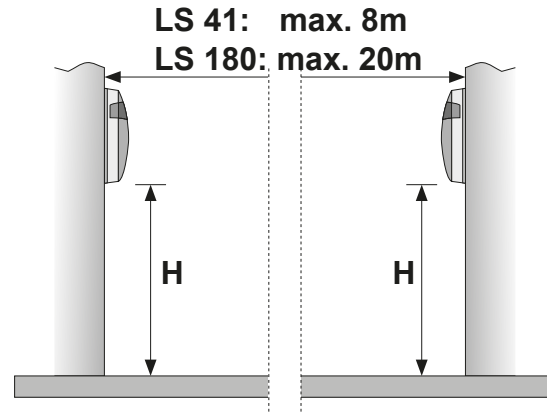

- For mounting the transmitter (receiver) remove the bottom part (U) of the front cover (press side and pull off).
- After loosening the underlying screw (S) the upper part (O) can be lifted off.
- Depending on whether the connection cable is fed from the rear or bottom, you either provide the housing base (GS) or the lower part of the front cover with an opening (B).
- Transfer the transmitter and receiver positions (P) of the four mounting holes in the base to the mounting surface (eg wall, column), drill holes and fasten the base.

- Now interrupt the infrared beam several times to control the response of the relay (switching).

At each interruption of the beam the LED 1 on the receiver should light up and the PW-LED extinguish.



ATTENTION:

- The optimal adjustment should be made with a voltmeter at the measuring points TP (+, -) of the receiver.
- The measured value should be 2,0–2,7V d.c. (with cover on transmitter).



The diameter of the mounting screw heads should be max 7mm so that the housing can be properly closed!



- Place back and screw top front cover (O). Place the bottom front cover (U) and check the response of the relay through beam interruption again several times.

- Lead connection cable through the rubber grommet (T) to the terminals and perform the connections according to these instructions and the corresponding control unit instructions. (The cables should be positioned so that excess lengths can be avoided).
- **Control Jumper (J) for SYNC function on the transmitter.**



During assembly make sure that the covers (O and U) are placed again correctly on the housing base (GS) - the photocell must be tightly closed!

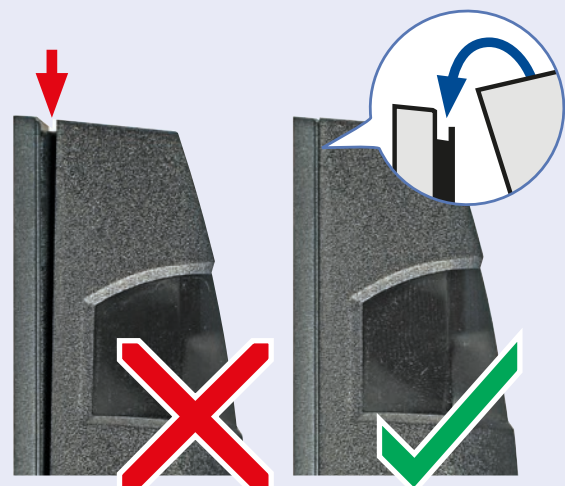

SYNC-Function	
Jumper J placed	SYNC-mode not activated
Jumper J removed	SYNC-mode activated

The SYNC-Function is only possible in AC operation.

- Transmitter and receiver with the correct voltage (12 bzw. 24 V a.c./d.c.) supply and by means of LED indicators confirm the connection or alignment.

LED-display		
Transmitter	PW-LED (red)	ON: supply of transmitter OK
Receiver	PW-LED (red)	ON: Photocell aligned
Receiver	LED 1 (red)	ON: Photocell not aligned or interrupted



Attention

- The manufacturer can not be held liable for damages resulting from improper or unreasonable use of the photocell!!

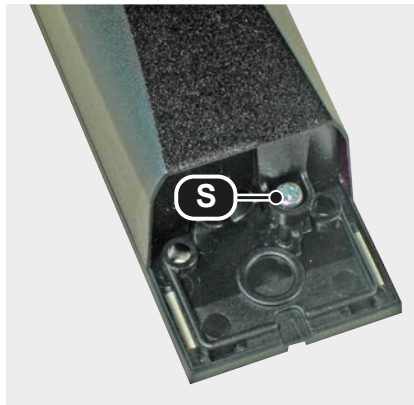
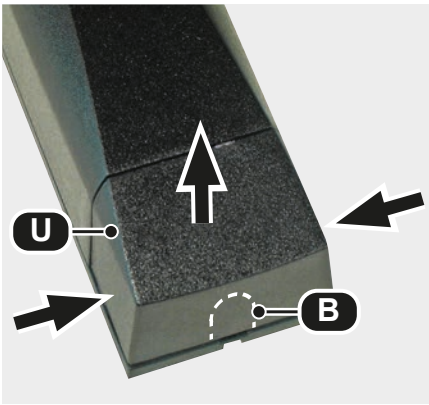

Important

- The opening (B) for cable feeder made must be sealed properly to prevent moisture entering into the housing!!

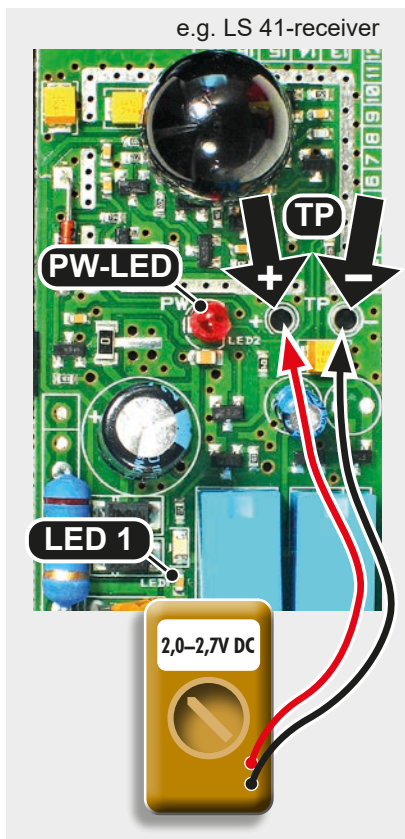
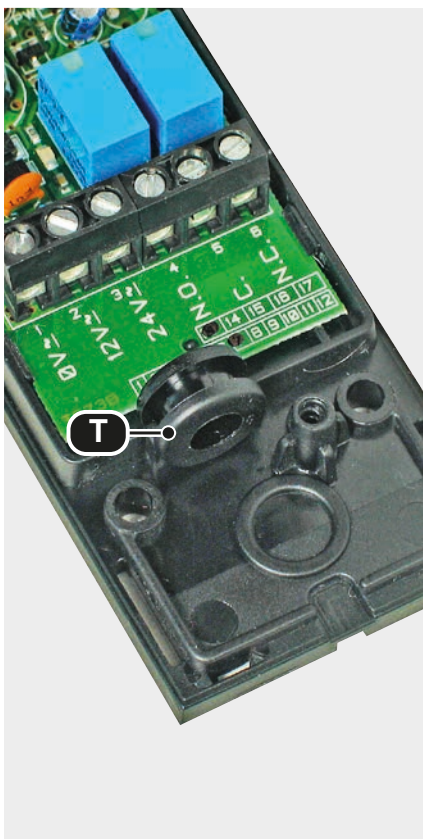
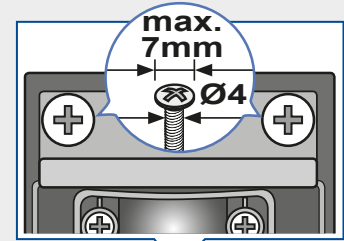
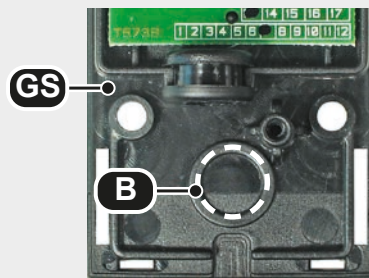
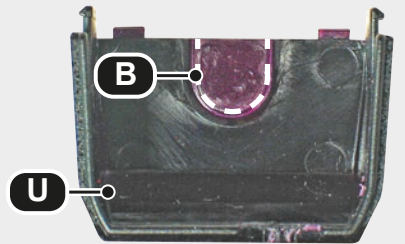
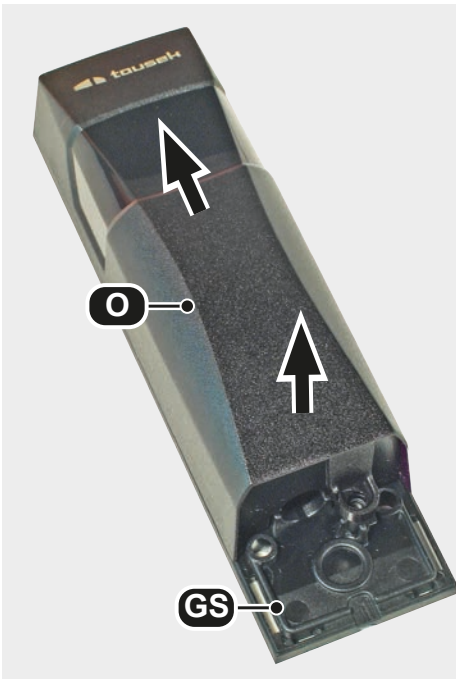

e.g. LS 180-transmitter

tousek PRODUCTS

- sliding gate operators
- cantilever systems
- swing gate operators
- garage door operators
- folding door operators
- traffic barriers
- electronic controls
- radio remote controls
- key operated switches
- access control
- safety devices
- accessories

Tousek Ges.m.b.H. Austria
A-1230 Vienna
Zetschegasse 1
Tel. +43/ 1/ 667 36 01
Fax +43/ 1/ 667 89 23
info@tousek.at

Tousek GmbH Germany
D-83395 Freilassing
Traunsteiner Straße 12
Tel. +49/ 8654/ 77 66-0
Fax +49/ 8654/ 57 196
info@tousek.de

Tousek Benelux NV
BE-3930 Hamont - Achel
Buitenheide 2A/ 1
Tel. +32/ 11/ 91 61 60
Fax +32/ 11/ 96 87 05
info@tousek.be

Tousek Sp. z o.o. Poland
PL 43-190 Mikołów (k/Katowic)
Gliwicka 67
Tel. +48/ 32/ 738 53 65
Fax +48/ 32/ 738 53 66
info@tousek.pl

Tousek s.r.o. Czech Republic
CZ-252 61 Jeneč u Prahy
Průmyslová 499
Tel. +420 / 777 751 730
info@tousek.cz



tousek[®]
G A T E A U T O M A T I O N

your service partner:

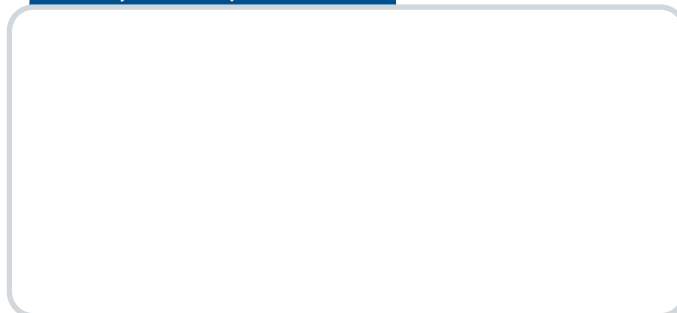

tousek

EN_LS-41-180_01
14. 11. 2018

We reserve the right to change dimensions and/or technical specifications without prior notice. Claims resulting from misprints or errors cannot be accepted.